



Katalog cevi za vodo
Water hoses catalogue

K A Z A L O I n d e n x

Uporaba fleksibilnih cevi za vodo	Str.	3
Pravila za montažo	Str.	4
Cev vezna - kotli ek.....	Str.	5
Cev vezna - el. bojler	Str.	6
Cev sanitarne armature DN6	Str.	7
Cev sanitarne armature DN8	Str.	8
Cev podaljšek DN8	Str.	9
Cev vezna DN10.....	Str.	10
Cev vezna DN12.....	Str.	11
Cev vezna DN20.....	Str.	12
Cev vezna DN25.....	Str.	13
Cev vezna DN32.....	Str.	14
Cev vezna DN40.....	Str.	15
Cev vezna DN50.....	Str.	16
Cev za tuš.....	Str.	17
Odto na cev.....	Str.	18
Kje nas najdete	Str.	19

<i>Application of flexible water hoses.....</i>	<i>Pag.</i>	<i>3</i>
<i>Installation rules.....</i>	<i>Pag.</i>	<i>4</i>
<i>Connection hose - toilet cistern</i>	<i>Pag.</i>	<i>5</i>
<i>Connection hose - water heater.....</i>	<i>Pag.</i>	<i>6</i>
<i>Faucet hose DN6.....</i>	<i>Pag.</i>	<i>7</i>
<i>Faucet hose DN8.....</i>	<i>Pag.</i>	<i>8</i>
<i>Extension hose DN8</i>	<i>Pag.</i>	<i>9</i>
<i>Connection hose DN10.....</i>	<i>Pag.</i>	<i>10</i>
<i>Connection hose DN12.....</i>	<i>Pag.</i>	<i>11</i>
<i>Connection hose DN20.....</i>	<i>Pag.</i>	<i>12</i>
<i>Connection hose DN25.....</i>	<i>Pag.</i>	<i>13</i>
<i>Connection hose DN32.....</i>	<i>Pag.</i>	<i>14</i>
<i>Connection hose DN40.....</i>	<i>Pag.</i>	<i>15</i>
<i>Connection hose DN50.....</i>	<i>Pag.</i>	<i>16</i>
<i>Shower hose.....</i>	<i>Pag.</i>	<i>17</i>
<i>Waste-pipe.....</i>	<i>Pag.</i>	<i>18</i>
<i>Where to find us.....</i>	<i>Pag.</i>	<i>19</i>

UPORABA FLEKSIBILNIH CEVI ZA VODO

Applications of flexible water hoses

SANITARNA

- Povezava med glavnim dovodom in razdelilnikom vode
- Povezava sanitarnih armatur
- Povezava tušev
- Povezava vodomerov
- Povezava aparatov za kavo in avtomatov za pijače
- Povezava pralnih strojev
- Povezava strojev za pranje posode
- Povezava filtrov za vodo

GRETJE

- Povezava radiatorjev
- Povezava grelnih enot, interne povezave znotraj grelnih enot
- Povezava toplotnih črpalk
- Primerne kot raztezni kompenzator med enotami

KLIMATIZACIJA

- Povezava obtoka hladne vode za klimatizacijo
- Povezava obtoka vode in kondenzatorja

TOPLLOTNE ČRPALKE

- Povezava voda/voda oziroma voda/zrak črpalke (priporočene so fleksibilne cevi, ker ne prenašajo vibracij motorja)

BOJLERJI

- Povezava tople in hladne vode

SONNI KOLEKTORJI

- Povezava med kolektorji
- Povezava med kolektorji in rezervoarjem
- Povezava med rezervoarjem in radiatorji

SANITARY

- Connection between main water pipe and water distributor
- Connection of water taps
- Connection of shower cabins
- Connection of washing machines
- Connection of dish washers
- Connection water meter
- Connection of coffee machines or vending machines for soft drinks
- Connection of waterpurifiers

HEATING

- Connection of radiators
- Connection of the heating unit, internal connection within the unit
- Connection of heat exchange pumps
- Connection of fan coil convectors · Suitable as an extension joint

AIR CONDITIONING

- Connection of cold water circuit for climatization
- Connection of water circuit and air conditioning condenser

HEAT EXCHANGE PUMPS

- Connection of water/water or water/air pumps (flexible hoses are recommended for they do not transmit vibrations caused by the motor)

BOILERS

- Connection of hot and cold water

SOLAR PANELS

- Connection between panels
- Connection between panel and reservoir tank
- Connection between tank and radiator

PREDNOSTI PRI UPORABI

Application advantages

Cevi ni potrebno spajkati, s tem znatno pridobimo na času (kar ni zanemarljivo). Montažo lahko odložimo na zadnjo minuto • Eliminirajo problem raztezanja cevi zaradi toplote • Eliminirajo hrup povzročen od krožnih črpalk • Enostavna montaža s stroški nižjimi od 20% - 50% glede na toge cevi, še posebej če jih je potrebno montirati na težavnih mestih.

No brazing needed, with a considerable gain of time (not to be underestimated). Connection can be postponed to the last minute • Eliminates the problems caused by extension of pipes due to heat • Eliminates noises caused by circulation pumps • Easy installation with a reduction of costs from 20% up to 50% in relation to rigid piping, especially when these are difficult to align.

MOŽNE KOMBINACIJE MED CEVMI IN PRIKLJUŽKI

Possible combinations between hoses and fittings

Ker v katalogu ni bilo mogoče predstaviti vseh možnih kombinacij cevi in priključkov, nas glede posebnih želja kontaktirajte po telefonu, fax-u, ali elektronski pošti.

Since it was not possible for us to present all combinations between hoses and fittings, please contact us for your specific desires per telephone, by fax, or by E-mail.

PRAVILA ZA MONTAŽO FLEKSIBILNIH CEVI

Installation rules of our flexible hoses

Varnost - funkcionalnost naših fleksibilnih cevi je odvisna od pravilne montaže. Pri montaži je potrebno zagotoviti, da vgrajene cevi niso torzijsko obremenjene (zvite) in pretirano upognjene. Potrebno je upoštevati radij upogibanja.

Safety - function of our flexible hoses depend on the correct way of installation. During installation it is absolutely important to ensure that the hose is installed free from torsion and excessive tight bend, which cause a reduction on the permitted bend radius.

PRIMERI NEPRAVILNE INSTALACIJE / EXAMPLES OF WRONG INSTALLATION

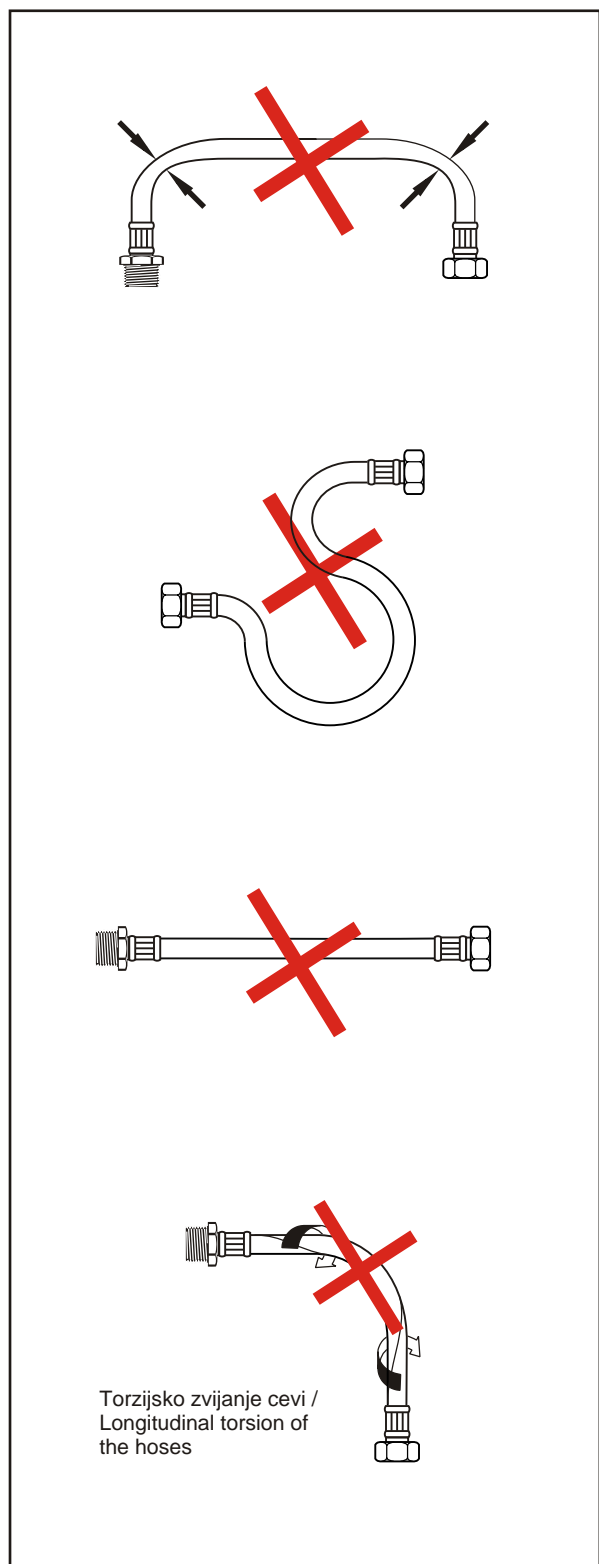

PRIMERI PRAVILNE INSTALACIJE / EXAMPLES OF CORRECT INSTALLATION

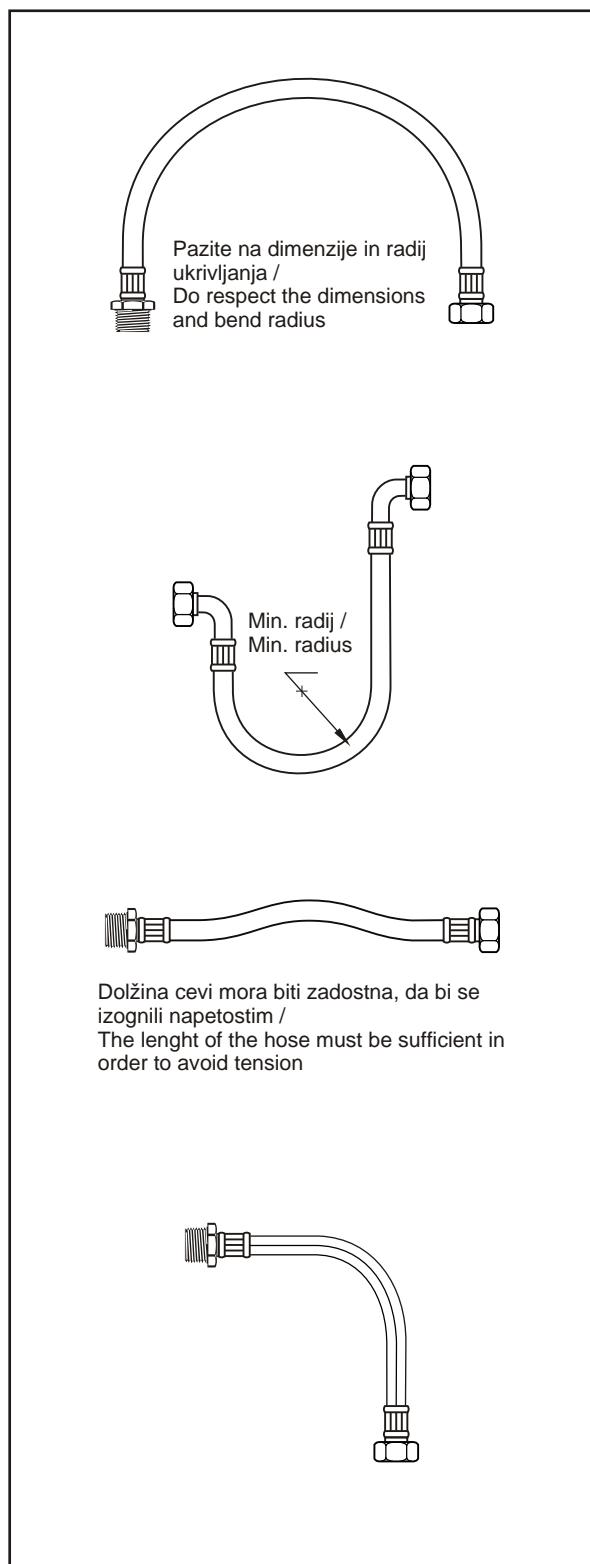

Cev vezna - kotli ek DN8 / *Connection hose - toilet cistern DN8*

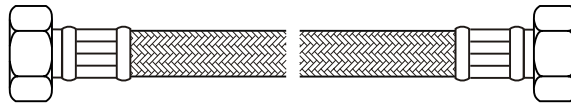

Cev - oznaka / <i>Hose - type</i>	Opis priklju kov / <i>Fitting description</i>
DN8 M38 M38 x L	matica 3/8" matica 3/8"
DN8 M12 M38 x L	matica 1/2" matica 3/8"
DN8 M12 M12 x L	matica 1/2" matica 1/2"

Z
Zunanji / *Male*

M
Matica / *Female*

Dolžina cevi po želji / *Hose length by desire*

EPDM gumijasta cev z AISI 304 nerjave im opletom, s priklju ki in objemkami iz ponikljane medenine.
Uporaba: Sanitarne aplikacije
Tehni ne informacije:
Delovni pritisk: 15 bar
Pritisk eksplozije: 90 bar
Radij ukrivljanja: 26 mm
Luknja cevi: 8 mm
Luknja priklju ka: 6 mm
Delovna temperatura: 90°C
Oplet: 7 žic iz nerjave ega jekla

EPDM rubber hose with stainless braiding AISI 304, with nickel plated brass fittings and ferrules.
Applications: Sanitary connection
Technical information:
Static pressure: 15 bar
Bursting pressure: 90 bar
Bend radius: 26 mm
Passage hose: 8 mm
Passage fitting: 6 mm
Operation temperature: 90°C
Braiding: 7 wires of stainless steel

Cev vezna - el. bojler DN10 / Connection hose - water heater DN10

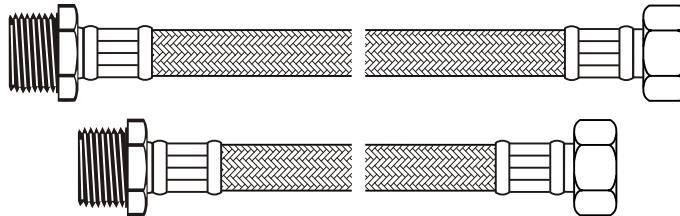

Cev - oznaka / Hose - type	Opis priklju kov / Fitting description
DN10 Z12 M12 x L	zunANJI 1/2" matica 1/2"

Z
Zunanji / Male

M
Matica / Female

Dolžina cevi po želji / Hose length by desire

EPDM gumijasta cev z AISI 304 nerjave im opletom, s priklju ki in objemkami iz ponikljane medenine.
 Uporaba: Sanitarne aplikacije - el. bojler
 Tehni ne informacije:
 Delovni pritisk: 15 bar
 Pritisk eksplozije: 90 bar
 Radij ukrivljanja: 50 mm
 Luknja cevi: 9,5 mm
 Luknja priklju ka: 7 mm
 Delovna temperatura: 90°C
 Oplet: 8 žic iz nerjave ega jekla

EPDM rubber hose with stainless braiding AISI 304, with nickel plated brass fittings and ferrules.
 Applications: Sanitary connection
 Technical information:
 Static pressure: 15 bar
 Bursting pressure: 90 bar
 Bend radius: 50 mm
 Passage hose: 9,5 mm
 Passage fitting: 7 mm
 Operation temperature: 90°C
 Braiding: 8 wires of stainless steel

Cev sanitarne armature DN6 / *Faucet hose DN6*

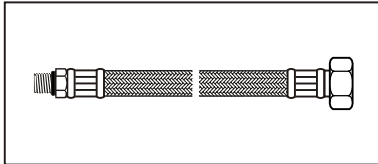

Cev - oznaka / Hose - type	Opis priklju kov / Fitting description
DN6 Z8 M38 x L	zunANJI 8x1 matica 3/8"
DN6 Z8 M12 x L	zunANJI 8x1 matica 1/2"

Z
ZunANJI / *Male*

M
Matica / *Female*

Dolžina cevi po želji / *Hose length by desire*

EPDM gumijasta cev z AISI 304 nerjave im opletom, s priklju ki in objemkami iz ponikljane medenine.
 Uporaba: Sanitarne aplikacije
 Tehni ne informacije:
 Delovni pritisk: 15 bar
 Pritisk eksplozije: 120 bar
 Radij ukrivljanja: 24 mm
 Luknja cevi: 6 mm
 Luknja priklju ka: 4,5 mm
 Delovna temperatura: 90°C
 Oplet: 6 žic iz nerjave ega jekla

EPDM rubber hose with stainless braiding AISI 304, with nickel plated brass fittings and ferrules.
 Applications: Sanitary connection
 Technical information:
 Static pressure: 15 bar
 Bursting pressure: 120 bar
 Bend radius: 24 mm
 Passage hose: 6 mm
 Passage fitting: 4,5 mm
 Operation temperature: 90°C
 Braiding: 6 wires of stainless steel

Cev sanitarne armature DN8 / Faucet hose DN8

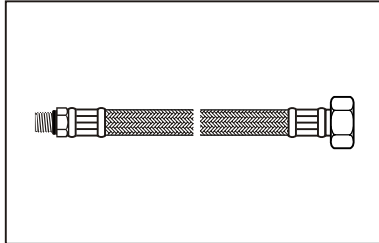

Cev - oznaka / Hose - type	Opis priklju kov / Fitting description
DN8 Z8 M38 x L	zunanj 8x1 matica 3/8"
DN8 Z8 M12 x L	zunanj 8x1 matica 1/2"
DN8 Z10 M38 x L	zunanj 10x1 matica 3/8"
DN8 Z10 M12 x L	zunanj 10x1 matica 1/2"
DN8 Z12 M38 x L	zunanj 12x1 matica 3/8"
DN8 Z12 M12 x L	zunanj 12x1 matica 1/2"

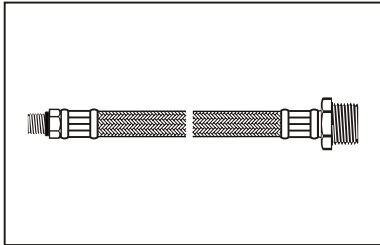

DN8 Z8 M38 x L	zunanj 8x1 zunanj 3/8"
DN8 Z8 M12 x L	zunanj 8x1 zunanj 1/2"
DN8 Z10 M38 x L	zunanj 10x1 zunanj 3/8"
DN8 Z10 M12 x L	zunanj 10x1 zunanj 1/2"
DN8 Z12 M38 x L	zunanj 12x1 zunanj 3/8"
DN8 Z12 M12 x L	zunanj 12x1 zunanj 1/2"

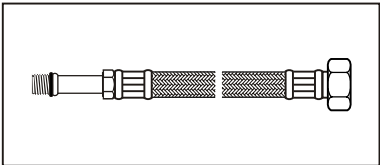

DN8 P8 M38 x L	podaljšan 8x1 matica 3/8"
DN8 P8 M12 x L	podaljšan 8x1 matica 1/2"
DN8 P10 M38 x L	podaljšan 10x1 matica 3/8"
DN8 P10 M12 x L	podaljšan 10x1 matica 1/2"

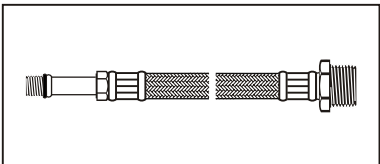

DN8 P8 Z38 x L	podaljšan 8x1 zunanj 3/8"
DN8 P8 Z12 x L	podaljšan 8x1 zunanj 1/2"
DN8 P10 Z38 x L	podaljšan 10x1 zunanj 3/8"
DN8 P10 Z12 x L	podaljšan 10x1 zunanj 1/2"

Z
Zunanj / Male

M
Matica / Female

P
Podaljšan zunanj /
Elongate male

Dolžina cevi po želji / Hose length by desire

EPDM gumijasta cev z AISI 304 nerjave im opletom, s priklju ki in objemkami iz ponikljane medenine.

Uporaba: Sanitarne aplikacije

Tehni ne informacije:

Delovni pritisk: 15 bar

Pritisk eksplozije: 90 bar

Radij ukrivljanja: 26 mm

Luknja cevi: 8 mm

Luknja priklju ka: 6 mm

Delovna temperatura: 90°C

Oplet: 7 žic iz nerjave ega jekla

EPDM rubber hose with stainless braiding AISI 304, with nickel plated brass fittings and ferrules.

Applications: Sanitary connection

Technical information:

Static pressure: 15 bar

Bursting pressure: 90 bar

Bend radius: 26 mm

Passage hose: 8 mm

Passage fitting: 6 mm

Operation temperature: 90°C

Braiding: 7 wires of stainless steel

Cev podaljšek DN8 / Extension hose DN8

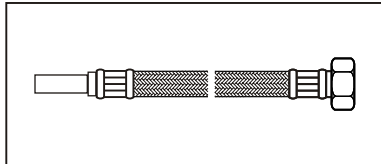

Cev - oznaka / Hose - type	Opis priključka / Fitting description
DN8 F10 M38 x L	ravni Ø10 matica 3/8"
DN8 F10 M12 x L	ravni Ø10 matica 1/2"

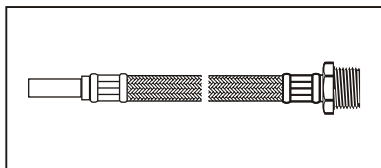

DN8 F10 Z38 x L	ravni Ø10 zunanji 3/8"
DN8 F10 Z12 x L	ravni Ø10 zunanji 1/2"

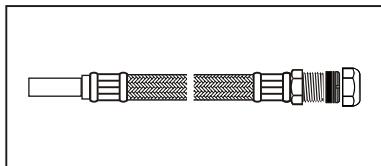

DN8 F10 D38 x L	ravni Ø10 dvodelen 3/8"
-----------------	-------------------------

Z
Zunanji / Male
M
Matica / Female
F
Ravni / Standpipe
D
Dvodelen / Bicone

Dolžina cevi po želji / Hose length by desire

EPDM gumijasta cev z AISI 304 nerjave im opletom, s priključki in objemkami iz ponikljane medenine.
 Uporaba: Sanitarne aplikacije
 Tehni ne informacije:
 Delovni pritisk: 15 bar
 Pritisk eksplozije: 90 bar
 Radij ukrivljanja: 26 mm
 Luknja cevi: 8 mm
 Luknja priključka: 6 mm
 Delovna temperatura: 90°C
 Oplet: 7 žic iz nerjave ega jekla

EPDM rubber hose with stainless braiding AISI 304, with nickel plated brass fittings and ferrules.
 Applications: Sanitary connection
 Technical information:
 Static pressure: 15 bar
 Bursting pressure: 90 bar
 Bend radius: 26 mm
 Passage hose: 8 mm
 Passage fitting: 6 mm
 Operation temperature: 90°C
 Braiding: 7 wires of stainless steel

Cev vezna DN10 / Connection hose DN10

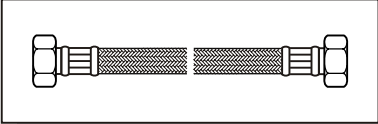
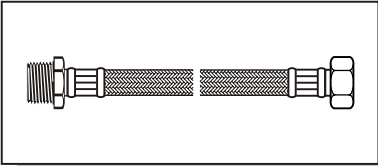
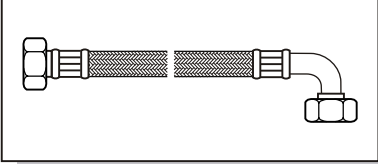
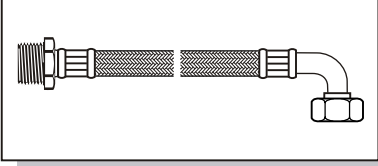
Cev - oznaka / Hose - type	Opis priklju kov / Fitting description
 DN10 M38 M38 x L	matica 3/8" matica 3/8"
DN10 M12 M38 x L	matica 1/2" matica 3/8"
DN10 M12 M12 x L	matica 1/2" matica 1/2"
 DN10 Z38 M38 x L	zunanji 3/8" matica 3/8"
DN10 Z12 M38 x L	zunanji 1/2" matica 3/8"
DN10 Z38 M12 x L	zunanji 3/8" matica 1/2"
DN10 Z12 M12 x L	zunanji 1/2" matica 1/2"
 DN10 M38 MK12 x L	matica 3/8" matica 90° 1/2"
DN10 M12 MK12 x L	matica 1/2" matica 90° 1/2"
 DN10 Z38 MK12 x L	zunanji 3/8" matica 90° 1/2"
DN10 Z12 MK12 x L	zunanji 1/2" matica 90° 1/2"

Z M K
Zunanji / Male Matica / Female Koleno 90° / Elbow 90°

Dolžina cevi po želji / Hose length by desire

EPDM gumijasta cev z AISI 304 nerjave im opletom, s priklju ki in objemkami iz ponikljane medenine.
Uporaba: Sanitarne aplikacije
Tehni ne informacije:
Delovni pritisk: 15 bar
Pritisk eksplozije: 90 bar
Radij ukrivljanja: 50 mm
Luknja cevi: 9,5 mm
Luknja priklju ka: 7 mm
Delovna temperatura: 90°C
Oplet: 8 žic iz nerjave ega jekla

EPDM rubber hose with stainless braiding AISI 304, with nickel plated brass fittings and ferrules.
Applications: Sanitary connection
Technical information:
Static pressure: 15 bar
Bursting pressure: 90 bar
Bend radius: 50 mm
Passage hose: 9,5 mm
Passage fitting: 7 mm
Operation temperature: 90°C
Braiding: 8 wires of stainless steel

Cev vezna DN12 / Connection hose DN12

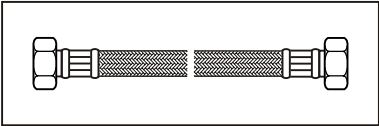
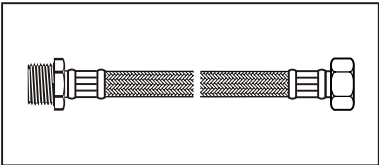
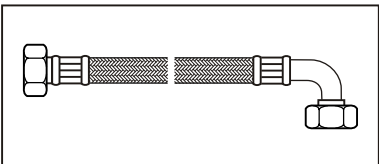
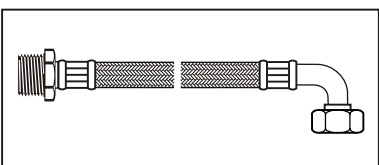
Cev - oznaka / Hose - type	Opis priklju kov / Fitting description
	DN12 M12 M12 x L matica 1/2" matica 1/2"
	DN12 M12 M34 x L matica 1/2" matica 3/4"
	DN12 M34 M34 x L matica 3/4" matica 3/4"
	DN12 Z12 M12 x L zunanji 1/2" matica 1/2"
	DN12 Z34 M12 x L zunanji 3/4" matica 1/2"
	DN12 Z12 M34 x L zunanji 1/2" matica 3/4"
	DN12 Z34 M34 x L zunanji 3/4" matica 3/4"
	DN12 M12 MK12 x L matica 1/2" matica 90° 1/2"
	DN12 M34 MK12 x L matica 3/4" matica 90° 1/2"
	DN12 M12 MK34 x L matica 1/2" matica 90° 3/4"
	DN12 M34 MK34 x L matica 3/4" matica 90° 3/4"
	DN12 Z12 MK12 x L zunanji 1/2" matica 90° 1/2"
	DN12 Z12 MK34 x L zunanji 1/2" matica 90° 3/4"
	DN12 Z34 MK12 x L zunanji 3/4" matica 90° 1/2"
	DN12 Z34 MK34 x L zunanji 3/4" matica 90° 3/4"

Z M K
Zunanji / Male Matica / Female Koleno 90° / Elbow 90°

Dolžina cevi po želji / Hose length by desire

EPDM gumijasta cev z AISI 304 nerjave im opletom, s priklju ki in objemkami iz ponikljane medenine.
Uporaba: Dovod vode za rpalke, grelce, vodovod, radiatorje, klimatske naprave, ...
Tehni ne informacije:
Delovni pritisk: 15 bar
Pritisk eksplozije: 90 bar
Radij ukrivljanja: 60 mm
Luknja cevi: 12 mm
Luknja priklju ka: 9 mm
Delovna temperatura: 90°C
Oplet: 9 žic iz nerjave ega jekla

EPDM rubber hose with stainless braiding AISI 304, with nickel plated brass fittings and ferrules.
Applications: Water supply for pumps, heaters, radiators, air conditioning systems, ...
Technical information:
Static pressure: 15 bar
Bursting pressure: 90 bar
Bend radius: 60 mm
Passage hose: 12 mm
Passage fitting: 9 mm
Operation temperature: 90°C
Braiding: 9 wires of stainless steel

Cev vezna DN20 / Connection hose DN20

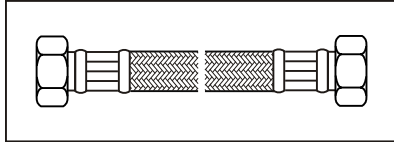

Cev - oznaka / Hose - type	Opis priklju kov / Fitting description
DN20 M34 M34 x L	matica 3/4" matica 3/4"

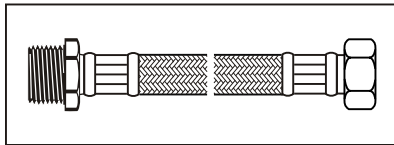

DN20 Z34 M34 x L	zunANJI 3/4" matica 3/4"
------------------	--------------------------

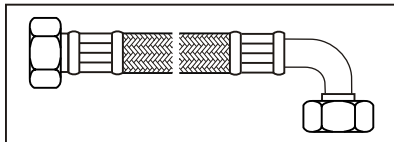

DN20 M34 MK34 x L	matica 3/4" matica 90° 3/4"
-------------------	-----------------------------

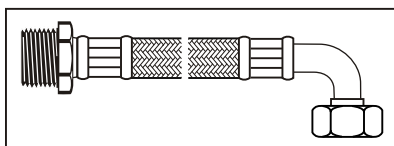

DN20 Z34 MK34 x L	zunANJI 3/4" matica 90 ° 3/4"
-------------------	-------------------------------



Z
Zunanji / Male
M
Matica / Female
K
Koleno 90° / Elbow 90°

Dolžina cevi po želji / Hose length by desire

EPDM gumijasta cev z AISI 304 nerjave im opletom, s priklju ki in objemkami iz ponikljane medenine.
 Uporaba: Dovod vode za rpalke, grelce, radiatorje, klimatske naprave, ...
 Tehni ne informacije:
 Delovni pritisk: 10 bar
 Pritisk eksplozije: 70 bar
 Radij ukrivljanja: 80 mm
 Luknja cevi: 19 mm
 Luknja priklju ka: 15 mm
 Delovna temperatura: 90°C
 Oplet: 10 žic iz nerjave ega jekla

EPDM rubber hose with stainless braiding AISI 304, with nickel plated brass fittings and ferrules.
 Applications: Water supply for pumps, heaters, radiators, air conditioning systems, ...
 Technical information:
 Static pressure: 10 bar
 Bursting pressure: 70 bar
 Bend radius: 80 mm
 Passage hose: 19 mm
 Passage fitting: 15 mm
 Operation temperature: 90°C
 Braiding: 10 wires of stainless steel

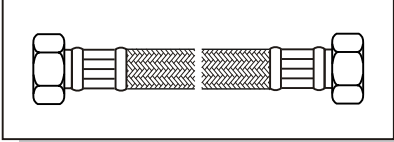
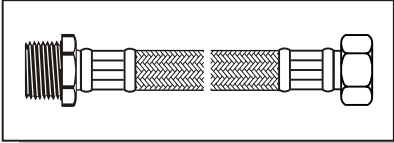
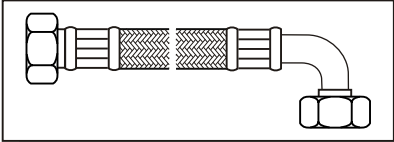
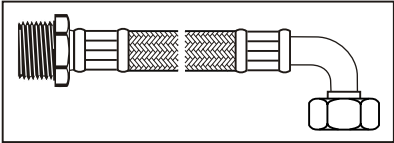
Cev vezna DN25 / Connection hose DN25

	Cev - oznaka / Hose - type	Opis priklju kov / Fitting description
	DN25 M1 M1 x L	matica 1" matica 1"
	DN25 Z1 M1 x L	zunANJI 1" matica 1"
	DN25 M1 MK1 x L	matica 1" matica 90° 1"
	DN25 Z1 MK1 x L	zunANJI 1" matica 90° 1"

Z Zunanji / Male M Matica / Female K Koleno 90° / Elbow 90°

Dolžina cevi po želji / Hose length by desire

EPDM gumijasta cev z AISI 304 nerjave im
 opletom, s priklju ki in objemkami iz
 ponikljane medenine.
 Uporaba: Dovod vode za rpalke, grelce,
 vodovod, radiatorje, klimatske naprave, ...
 Tehni ne informacije:
 Delovni pritisk: 10 bar
 Pritisk eksplozije: 60 bar
 Radij ukrivljanja: 100 mm
 Luknja cevi: 25 mm
 Luknja priklju ka: 20 mm
 Delovna temperatura: 90°C
 Oplet: 10 žic iz nerjave tega jekla

EPDM rubber hose with stainless braiding
 AISI 304, with nickel plated brass fittings
 and ferrules.
 Applications: Water supply for pumps,
 heaters, radiators, air conditioning systems, ...
 Technical information:
 Static pressure: 10 bar
 Bursting pressure: 60 bar
 Bend radius: 100 mm
 Passage hose: 25 mm
 Passage fitting: 20 mm
 Operation temperature: 90°C
 Braiding: 10 wires of stainless steel

Cev vezna DN32 / Connection hose DN32

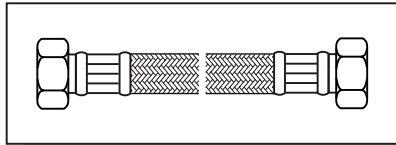

Cev - oznaka / Hose - type	Opis priklju kov / Fitting description
----------------------------	--

DN32 M54 M54 x L	matica 5/4" matica 5/4"
------------------	-------------------------

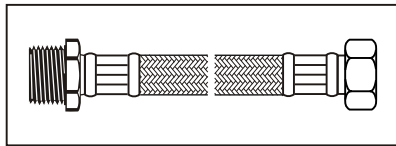

DN32 Z54 M54 x L	zunANJI 5/4" matica 5/4"
------------------	--------------------------

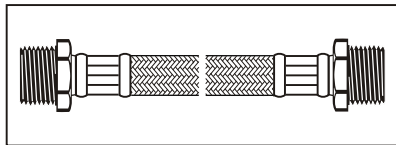

DN32 Z54 Z54 x L	zunANJI 5/4" zunANJI 5/4"
------------------	---------------------------

Z
ZunANJI / Male

M
Matica / Female

Dolžina cevi po želji / Hose length by desire

EPDM gumijasta cev z AISI 304 nerjave im opletom, s priklju ki in objemkami iz ponikljane medenine.

Uporaba: Dovod vode za rpalke, grelce, vodovod, radiatorje, klimatske naprave, ...

Tehni ne informacije:

Delovni pritisk: 10 bar

Pritisk eksplozije: 50 bar

Radij ukrivljanja: 160 mm

Luknja cevi: 32 mm

Luknja priklju ka: 26 mm

Delovna temperatura: 90°C

Oplet: 11 žic iz nerjave ega jekla

EPDM rubber hose with stainless braiding AISI 304, with nickel plated brass fittings and ferrules.

Applications: Water supply for pumps, heaters, radiators, air conditioning systems, ...

Technical information:

Static pressure: 10 bar

Bursting pressure: 50 bar

Bend radius: 160 mm

Passage hose: 32 mm

Passage fitting: 26 mm

Operation temperature: 90°C

Braiding: 11 wires of stainless steel

Cev vezna DN40 / Connection hose DN40

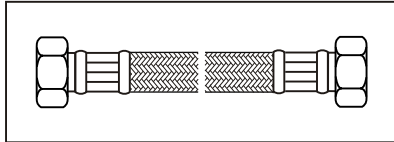

Cev - oznaka / Hose - type	Opis priklju kov / Fitting description
----------------------------	--

DN40 M64 M64 x L	matica 6/4" matica 6/4"
------------------	-------------------------

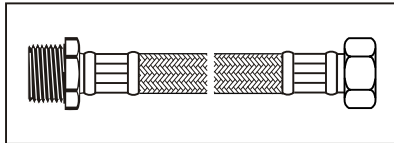

DN40 Z64 M64 x L	zunANJI 6/4" matica 6/4"
------------------	--------------------------

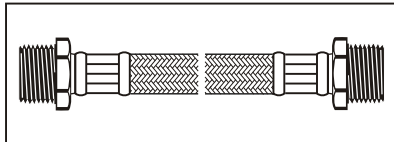

DN40 Z64 Z64 x L	zunANJI 6/4" zunANJI 6/4"
------------------	---------------------------

Z
ZunANJI / Male

M
Matica / Female

Dolžina cevi po želji / Hose length by desire

EPDM gumijasta cev z AISI 304 nerjave im opletom, s priklju ki in objemkami iz ponikljane medenine.

Uporaba: Dovod vode za rpalke, grelce, vodovod, radiatorje, klimatske naprave, ...

Tehni ne informacije:

Delovni pritisk: 6 bar

Pritisk eksplozije: 50 bar

Radij ukrivljanja: 180 mm

Luknja cevi: 40 mm

Luknja priklju ka: 32 mm

Delovna temperatura: 90°C

Oplet: 8 žic iz nerjave ega jekla

EPDM rubber hose with stainless braiding AISI 304, with nickel plated brass fittings and ferrules.

Applications: Water supply for pumps, heaters, radiators, air conditioning systems,...

Technical information:

Static pressure: 6 bar

Bursting pressure: 50 bar

Bend radius: 180 mm

Passage hose: 40 mm

Passage fitting: 32 mm

Operation temperature: 90°C

Braiding: 8 wires of stainless steel

Cev vezna DN50 / Connection hose DN50

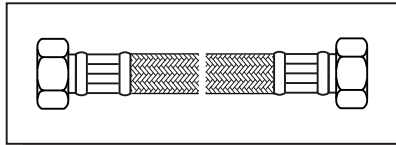

Cev - oznaka / Hose - type	Opis priklju kov / Fitting description
----------------------------	--

DN50 M2 M2 x L	matica 2" matica 2"
----------------	---------------------

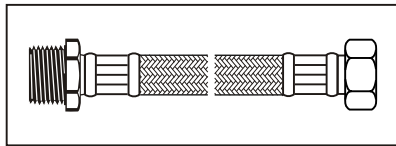

DN50 Z2 M2 x L	zunANJI 2" matica 2"
----------------	----------------------

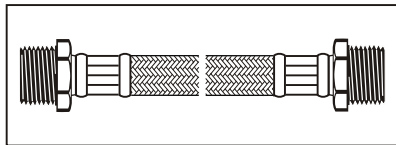

DN50 Z2 Z2 x L	zunANJI 2" zunANJI 2"
----------------	-----------------------

Z
ZunANJI / Male

M
Matica / Female

Dolžina cevi po želji / Hose length by desire

EPDM gumijasta cev z AISI 304 nerjave im opletom, s priklju ki in objemkami iz ponikljane medenine.

Uporaba: Dovod vode za rpalke, grelce, vodovod, radiatorje, klimatske naprave, ...

Tehni ne informacije:

Delovni pritisk: 6 bar

Pritisk eksplozije: 50 bar

Radij ukrivljanja: 180 mm

Luknja cevi: 40 mm

Luknja priklju ka: 32 mm

Delovna temperatura: 90°C

Oplet: 8 žic iz nerjave ega jekla

EPDM rubber hose with stainless braiding AISI 304, with nickel plated brass fittings and ferrules.

Applications: Water supply for pumps, heaters, radiators, air conditioning systems, ...

Technical information:

Static pressure: 6 bar

Bursting pressure: 50 bar

Bend radius: 180 mm

Passage hose: 40 mm

Passage fitting: 32 mm

Operation temperature: 90°C

Braiding: 8 wires of stainless steel

Cev za tuš - kromirana / Shower hose - chromium plated



Cev / Hose	Priklju ki / Fittings	Dolžina / Length	
Navita kromirana medenina / Stripwound chromed plated brass	Kromirana medenina / Chromium-plated brass	150	200

Cev za tuš - PVC / Shower hose - PVC



Cev / Hose	Priklju ki / Fittings	Dolžina / Length
PVC s spiralastim vzorcem / PVC with spiral pattern	Kromirana medenina / Chromium-plated brass	Po želji / By desire

Cev odvodna - za pralne stroje / *Waste pipe - for washing machines*



Cev / Hose	Dolžina / Length
PVC z gumijastimi nastavki / <i>PVC with rubber pieces</i>	1500
	2000
	2500
	3000

Cev dovodna - za pralne stroje / *Pipe for washing machines*



Cev / Hose	Opis priklju kov / <i>Fitting description</i>	Dolžina / Length
PVC	matica 3/4" 90° - matica 3/4"	1500
		2000
		2500
		3000

K J E N A S N A J D E T E

Where to find us

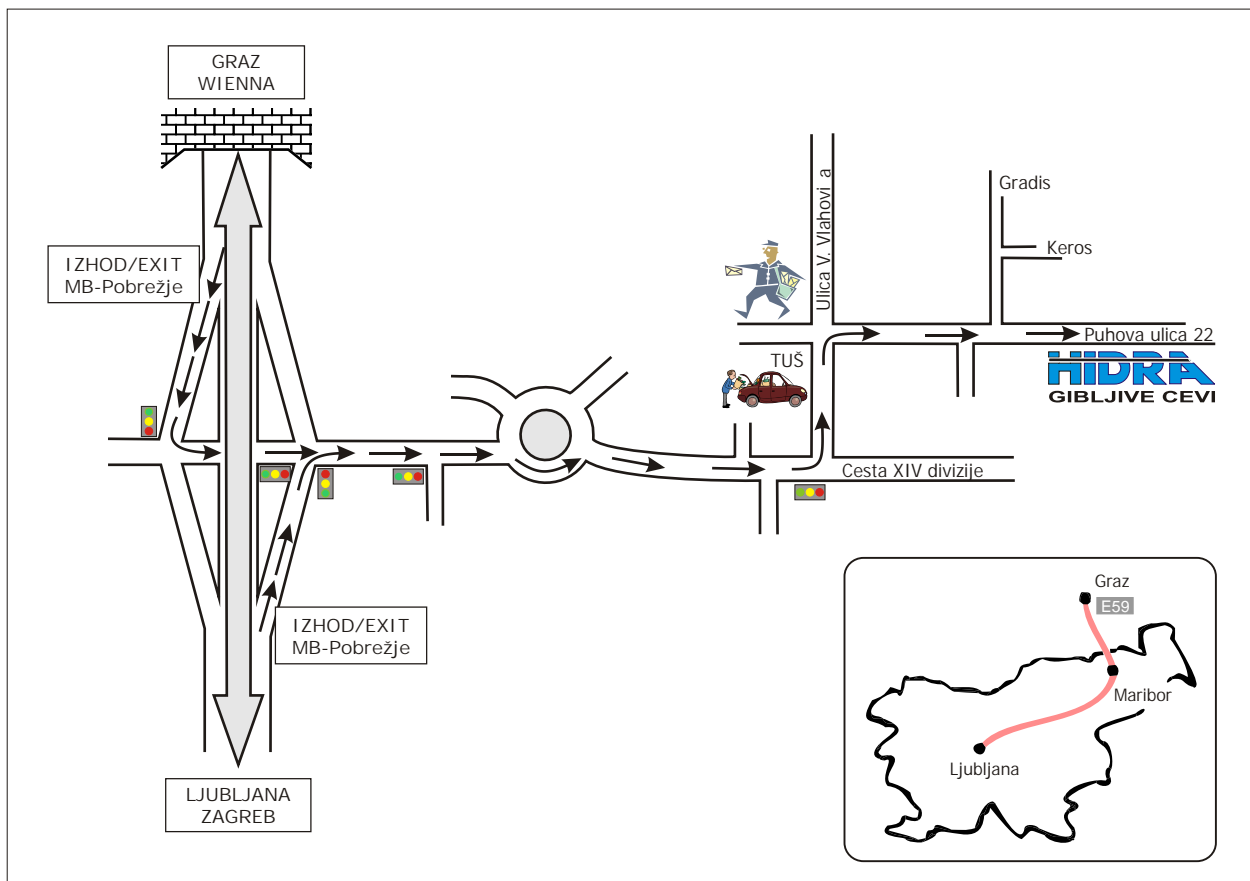

Hidra d.o.o.
Puhova ul. 22, Maribor
Tel.: 00386/2/4716153
00386/2/4716155
Fax: 00386/2/4716154

Tehni ne informacije v tem katalogu so lahko podvržene spremembam brez dodatnega obvestila. Opravi ujemo se za možne napake v tisku.
Datum izdaje 6/11/2003

All kind of technical information stated in this catalogue is subject to be changed without further advice, printing errors reserved.
Date 6/11/2003